



ヨドコウ

アール折板屋根 ラジアル工法

屋根材

軒先のR形状により、雨やゴミの吹き込みを防ぐ優美なデザイン。

アール折板屋根

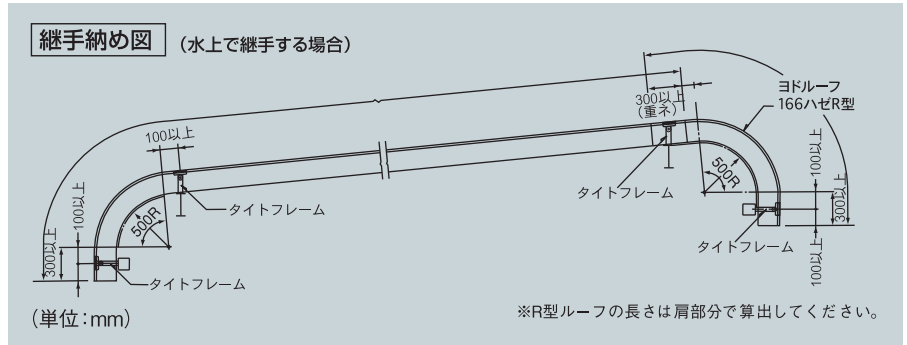
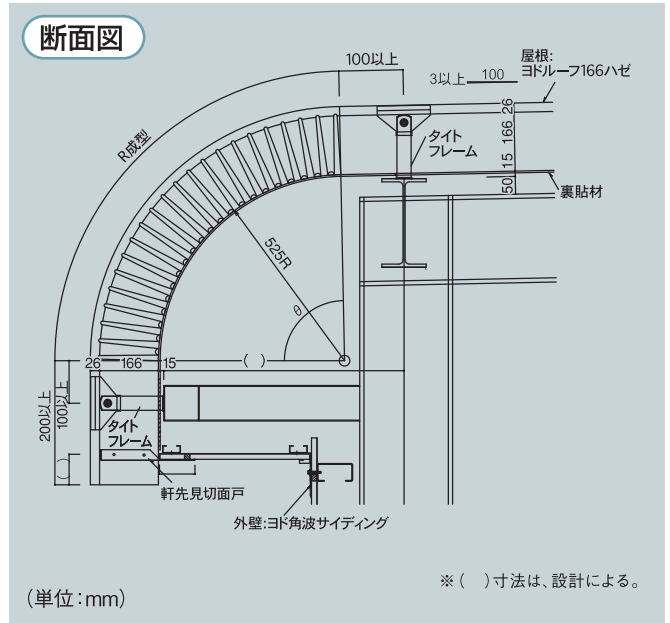

断面形状

R折板に使用する屋根形

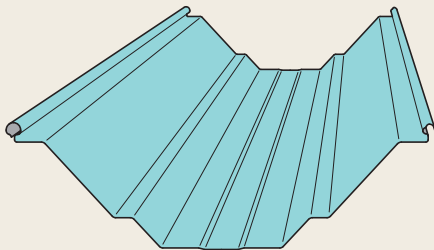

ヨドルーフ140ハゼ

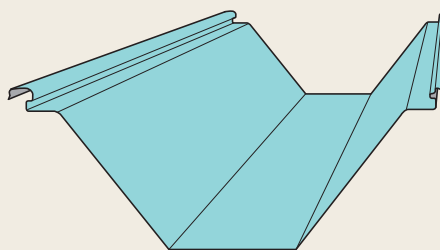

ヨドルーフ166ハゼ

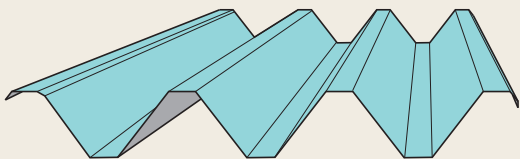

ヨドルーフ88

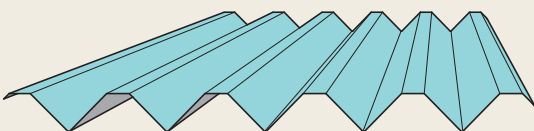

ヨドルーフ50

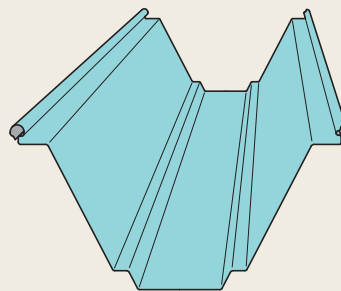

ヨドルーフ192ハゼ

R折板屋根の加工形式

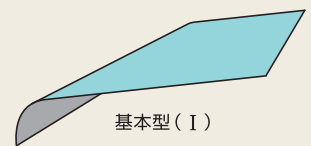

基本型 (I)

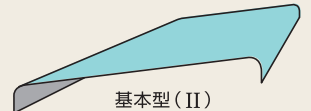

基本型 (II)

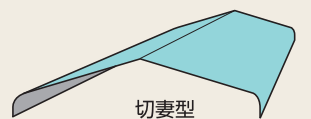

切妻型



アーチ型